

Bodenleitsystem - Krampe Floor Guidance System - Staple



erhältliche Standardformate:
available formats:

HxB / HxW

Rund Ø 23,8 mm

Eckig 29 x 13,8 mm

1 Schutzfolie abziehen
Remove the protective film



2

Selbstklebend
self-adhesive

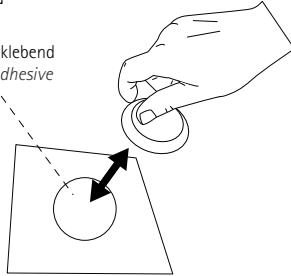

3

Selbstklebend
self-adhesive

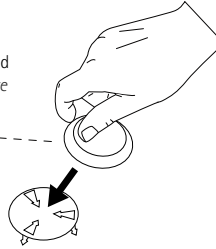

4

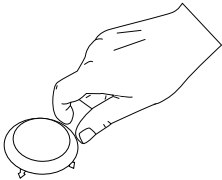

5

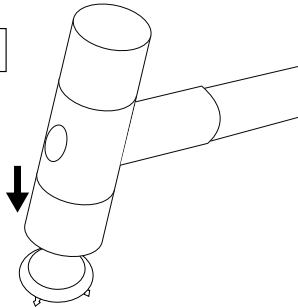

6



1 Schutzfolie abziehen
Remove the protective film

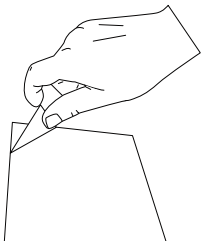

2

Selbstklebend
self-adhesive

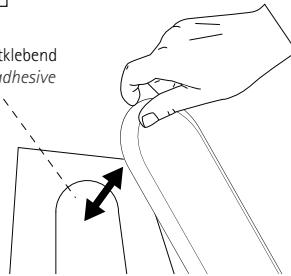

3

Selbstklebend
self-adhesive

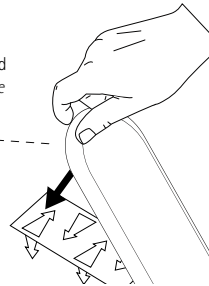

3 Krampen je Leitstreifen benötigt
Links - Mitte - Rechts
3 staples per guiding strip needed
left - middle - right

4

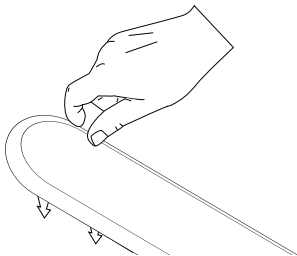

5

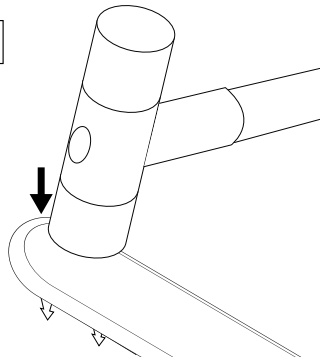

6

